

### TY - 302P

#### Description:

The TY series transformers are used for a variety of applications including impedance matching, isolation, repeat coil, line balancing, bridging and hybrid circuit.

#### Electrical Specifications at 25° C:

Impedance (Ohms)		Max. DC Current (mA)	Typ. Insertion Loss (dB)	Typ. Return Loss (dB)	Trans-Hybrid Loss (dB)
Pri	Sec				
600 (4W)	600/600	0	.65	32	55

#### Designed to meet FCC Part 68

**Longitudinal Balance:** (FCC 68.310) – 60 dB min. 200 – 1000 Hz  
45 dB min. 1000 – 4000 Hz

**Dielectric Strength:** (FCC 68.304) – 1500VAC

**Power Level:** -45 dBm to +7 dBm

**Frequency Range:** 300 to 3500 Hz

#### Electrical Schematic:

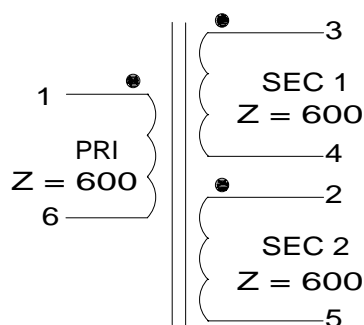

**RoHS Compliance:** As of manufacturing date February 2005, all standard products meet the requirements of 2002/95/EC, known as the RoHS initiative.

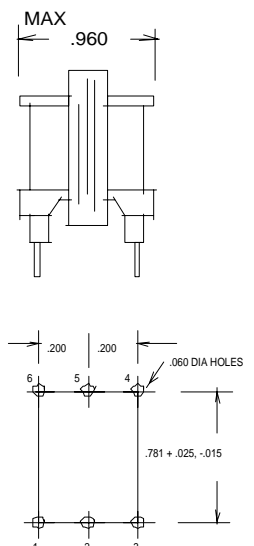
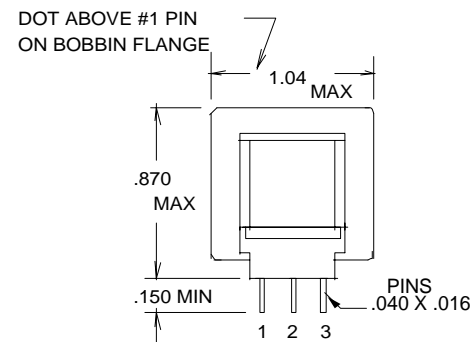
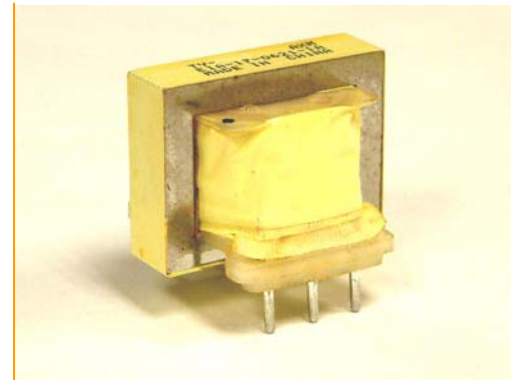

# Audio Transformers

## Data / Voice Coupling

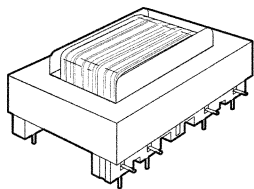

Figure A

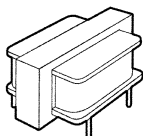

Figure B

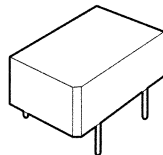

Figure C

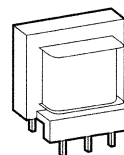

Figure D

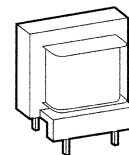

Figure E

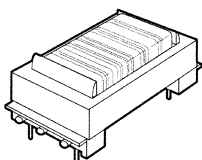

Figure F

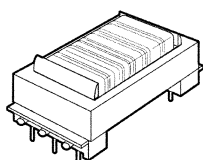

Figure G

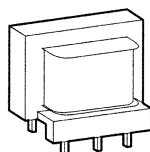

Figure H

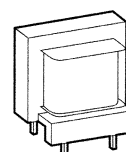

Figure I

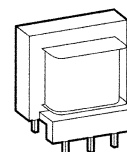

Figure J

### :: Description

Triad telecommunications transformers are designed to meet the requirements for access over leased private lines or through the dial-up switched telephone network. The TY series transformers are used for a variety of applications including impedance matching, isolation, repeat coil, line balancing, bridging, and hybrid circuits.

### :: Specifications

**Designed to meet FCC Part 68**

**Longitudinal Balance:** (FCC 68.310) - 60 dB min. 200 - 1,000 Hz  
45 dB min. 1,000 - 4,000 Hz

**Dielectric Strength:** (FCC 68.304) - 1,500 V

**Power Level:** -45 dBm to +7 dBm

**Frequency Range:** Data / Voice = 300 to 3,500 Hz  
Data = 800 to 3,500 Hz

### :: Data/Voice Coupling Transformers

Section	Type No.	Impedance (Ohms)		Max. DC Current (mA)	Typ. Insertion Loss (dB)	Typ. Return Loss (dB)	Typ. Freq. Response (dB)	Schematic	Figure
		Pri.	Sec.						
A	TY-305P	600	600	100	1.5	10	±5	1	A
B	TY-306P	600 Split	600	75	1.5	10	±5	2	A
C	TY-307P	600	600	0	1.0	26	±5	3	B
D	TY-310P	600	600	0	1.0	26	±5	3	C
E	TY-311P	600	600	0	1.0	26	±5	3	E
F	TY-304P	600 CT	600 CT	0	1.0	26	±5	4	D
G	TY-301P	600	900	0	1.0	26	±5	5	E
H	TY-303P	4000	600	0	1.0	26	±5	6	E

CT = Center Tap

### :: Data/Voice Coupling Transformers

Section	Type No.	Impedance (Ohms)		Max. DC Current (mA)	Typ. Insertion Loss (dB)	Typ. Return Loss (dB)	Typ. Freq. Response (dB)	Schematic	Figure
		Pri.	Sec.						
I	TY-400P	600	600	90	1.75	15	±5	3	I
J	TY-401P	600 CT	600 CT	90	1.75	15	±5	4	J
K	TY-402P	600	600	90	1.75	13	±5	7	F
L	TY-403P	600	600 Split	90	1.75	13	±5	8	G

CT = Center Tap

### :: Data/Voice Single Transformer Hybrids

Section	Type No.	Impedance (Ohms)		Max. DC Current (mA)	Typ. Insertion Loss (dB)	Typ. Return Loss (dB)	Trans-Hybrid Loss (dB)	Schematic	Figure
		Pri.	Sec.						
M	TY-300P	600 (4W)	600/600	0	.80	30	50	9	D
N	TY-302P	600 (4W)	600/600	0	.65	32	55	9	H

Outline Dimensions

Technical Notes

Primary connections shown on left side of schematics.

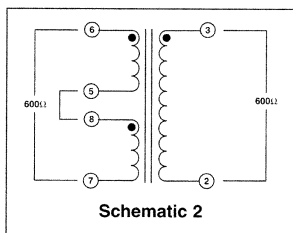
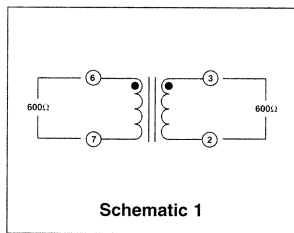

Figure A

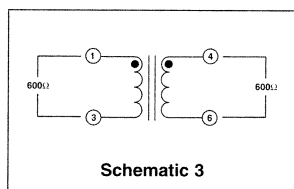
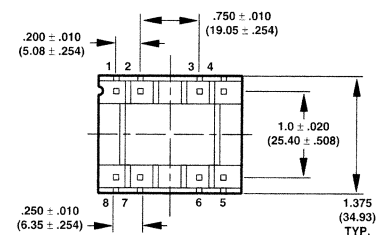
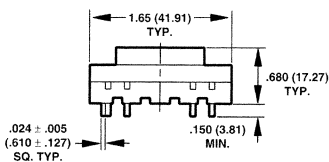

Figure B

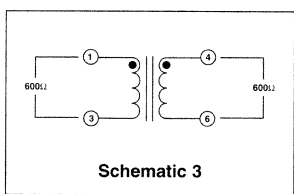
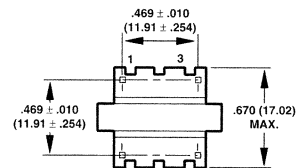
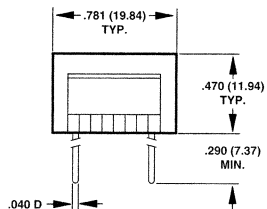

Figure C

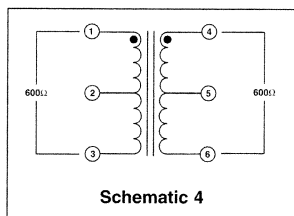
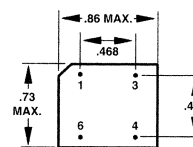
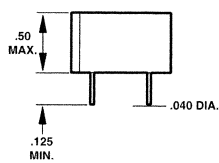

Figure D

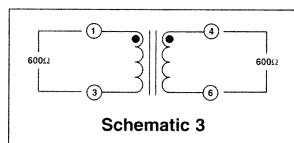
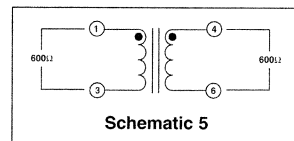
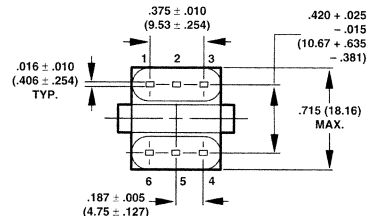
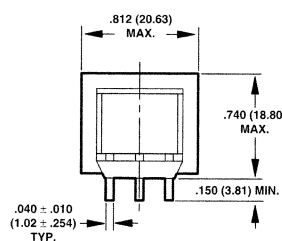
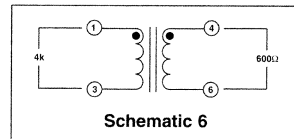
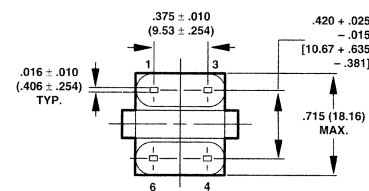
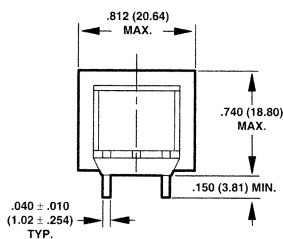

Figure E



Outline Dimensions

